

SPECIFICATIONS / TECHNICAL DATA

**MIRROR
RECTANGULAR
ROUND CORNERS**

20" x 28"

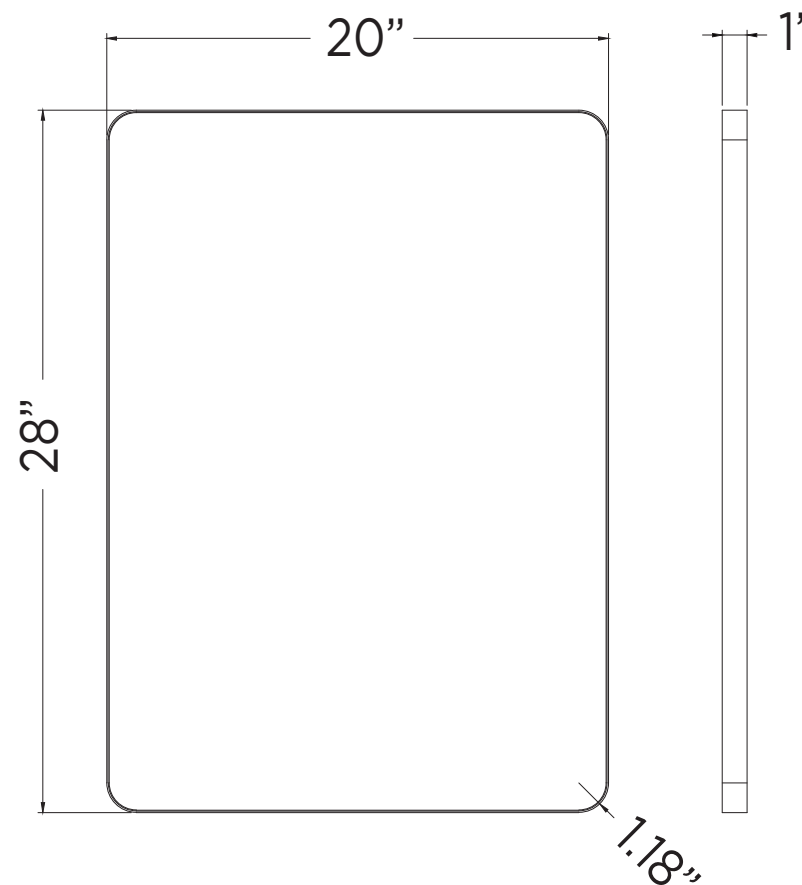

ATTENTION! Dimensions may vary by up to 3/8". It is highly recommended to pull all dimensions of actual model for installation and measuring purposes.

MODEL# MRR2028