

SPECIFICATIONS / TECHNICAL DATA

MEDICINE CABINET ALUMINUM

20" x 24"

CUTOUT DIMENSIONS:

19 ²/₅" x 23 ²/₅" x 4 ³/₅"

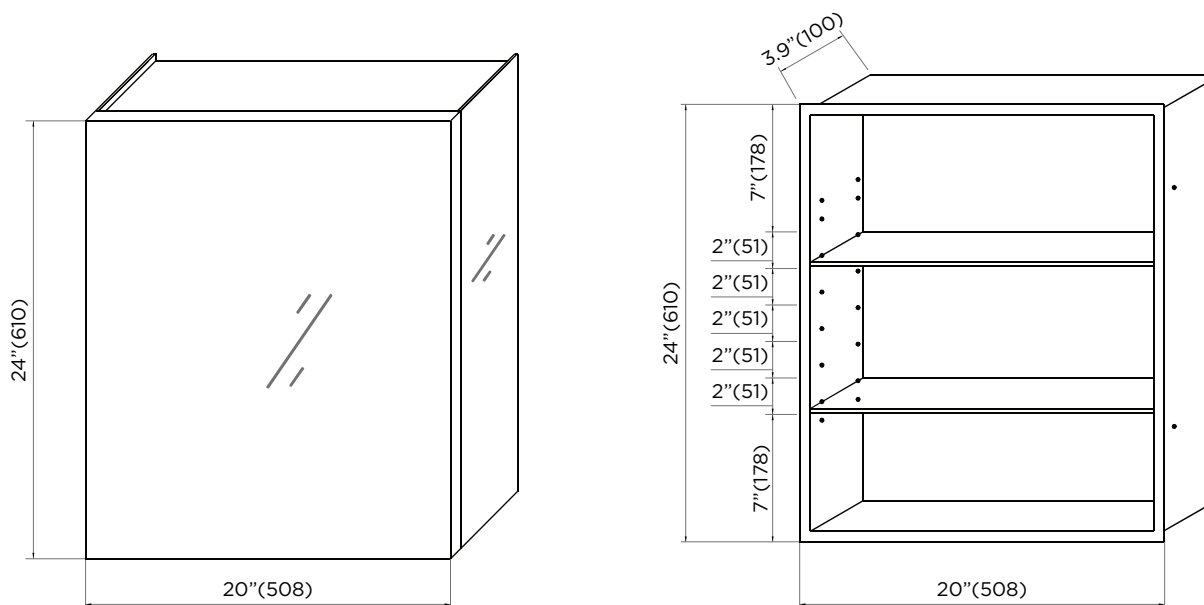

ATTENTION! Dimensions may vary by up to 3/8". It is highly recommended to pull all dimensions of actual model for installation and measuring purposes.

MODEL# AMA2024