

**SPECIFICATIONS / TECHNICAL DATA**

# MEDICINE CABINET

## ALUMINUM

**24" x 24"**

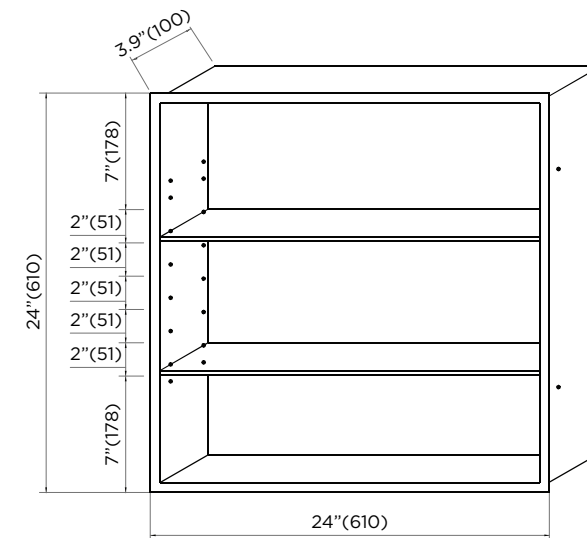
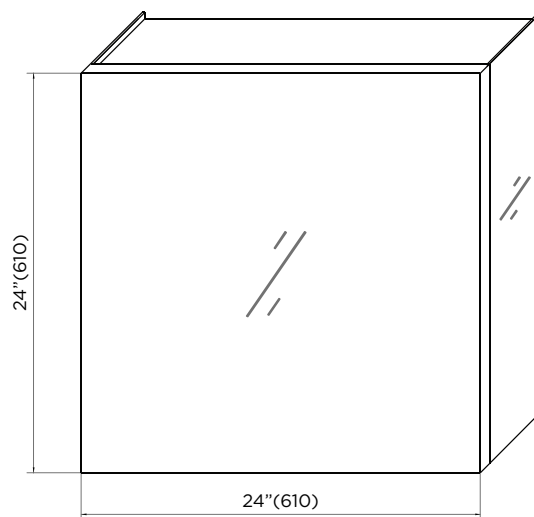

**CUTOUT DIMENSIONS:**

**23 <sup>2</sup>/<sub>5</sub>" x 23 <sup>2</sup>/<sub>5</sub>" x 4 <sup>3</sup>/<sub>5</sub>"**

*ATTENTION! Dimensions may vary by up to 3/8". It is highly recommended to pull all dimensions of actual model for installation and measuring purposes.*

**MODEL# AMA2424**