

SPECIFICATIONS / TECHNICAL DATA

VANITY COLLECTION

OAKVILLE

48"

WALL HUNG

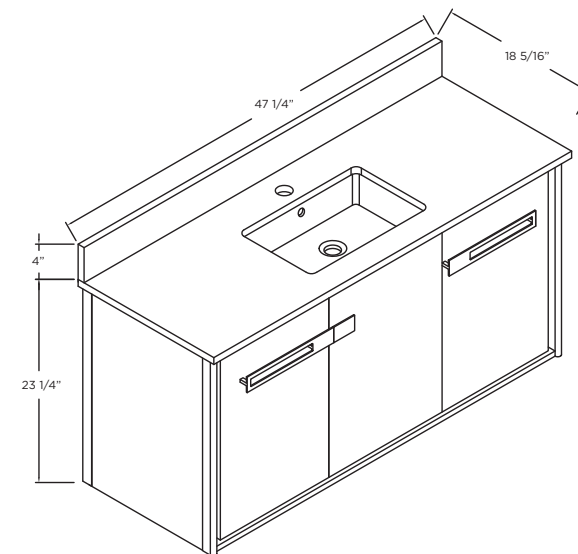
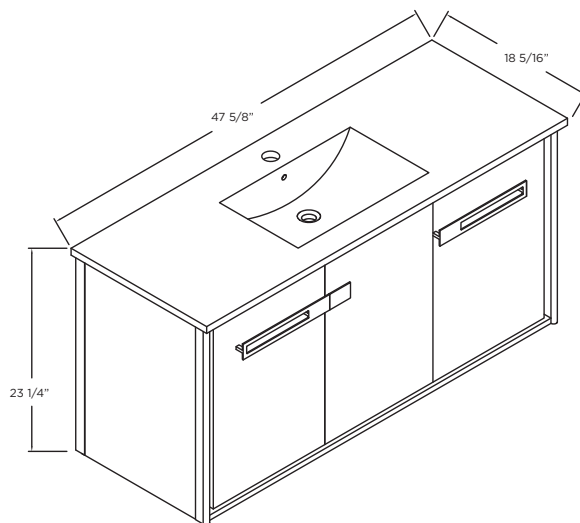
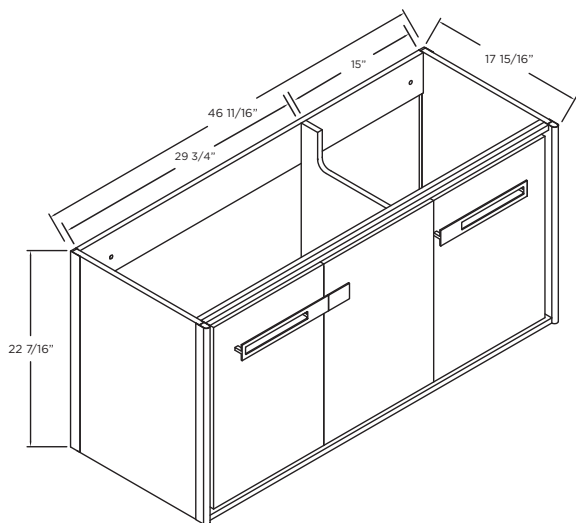
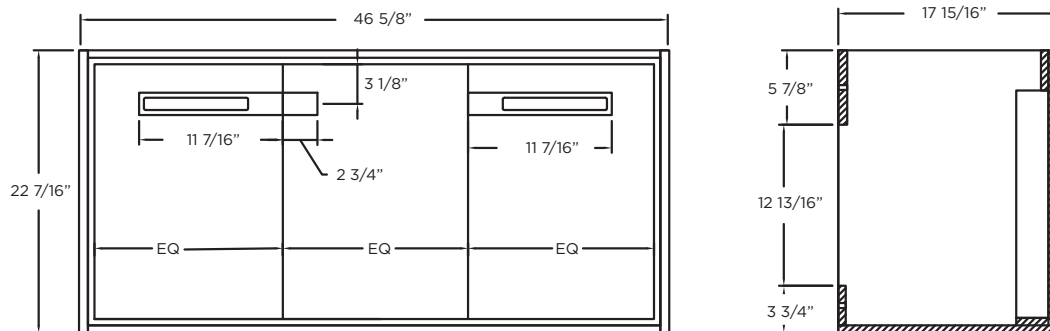

ATTENTION! Dimensions may vary by up to 3/8". It is highly recommended to pull all dimensions of actual model for installation and measuring purposes.

MODEL# OK48