

SPECIFICATIONS/TECHNICAL DATA

SHOWER BASE

RIGHT DOUBLE THRESHOLD

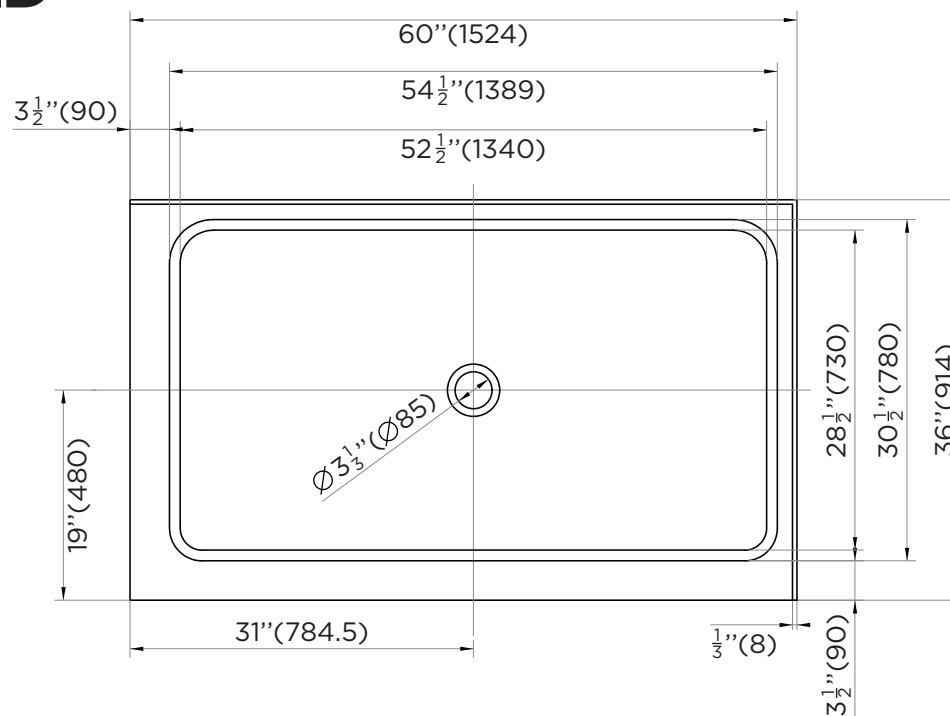
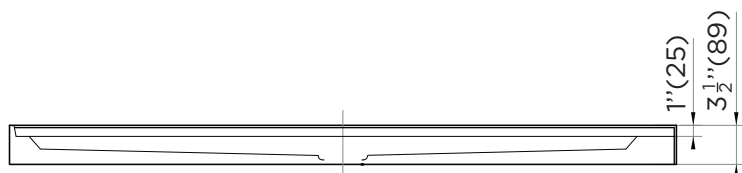

ATTENTION! Dimensions may vary by up to 3/8". It is highly recommended to pull all dimensions of actual model for installation and measuring purposes.

MODEL# SBA6036W-R